

# BLUETAKE BT510 Extra Function

## - Appearance -

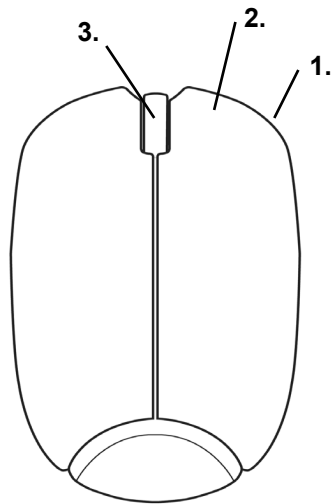

1. Right Button
2. Scrolling Wheel
3. Left Button
4. Spare USB Power Supply Jack
5. Sensor LED (Red)
6. Pairing LED (Blue)
7. Upper Cover Lock
8. Power Switch
9. Pairing Button

**Note:** For the max. power saving, please turn the BT510 power off when you shut-down your computer.

## - Button Switch -

1. Press and hold both scrolling wheel and left button (or right button) for 3 seconds, then release buttons.

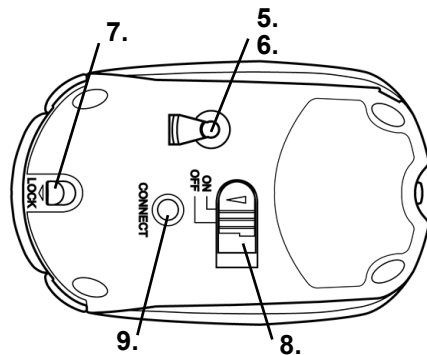
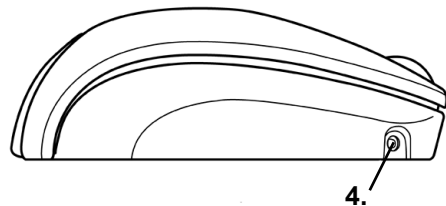
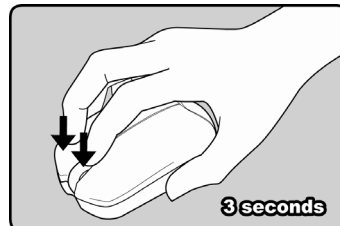
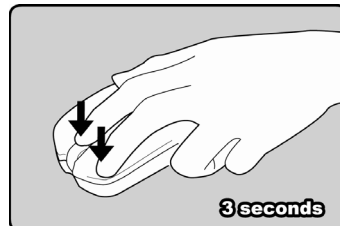

2. The left button and right button had been reversed.



3. If you want to switch buttons back to its original function definition, please repeat the step 1. and step 2.

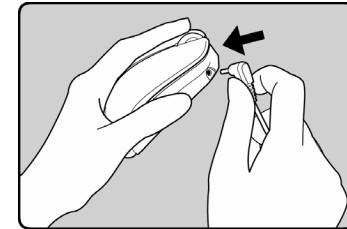

3. The power supply of BT510 will be switched to USB power automatically.

**Note:** Please only use this spare USB cable while your BT510 runs out of batteries power and has no new AAA batteries to replace the old batteries.



[www.bluetake.com](http://www.bluetake.com)

[bluetake@bluetake.com](mailto:bluetake@bluetake.com)

Copyright © 2005 Bluetake Technology Co., Ltd. All Rights Reserved.

Trademark(s)™ and Registered Trademark(s)®

The "Bluetake" name and logo are trademarks of Bluetake Technology Co., Ltd.

The "Bluetooth" word mark and logos are owned by the Bluetooth SIG, Inc. and any use of such marks by Bluetake Technology Co., Ltd. is under license.

## - Spare USB Power Supply -

1. Insert USB connector of spare USB power cable into your computer.

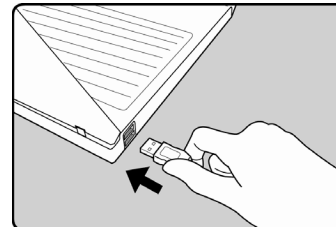

2. Insert DC power connector of spare USB power cable into your BT510.